

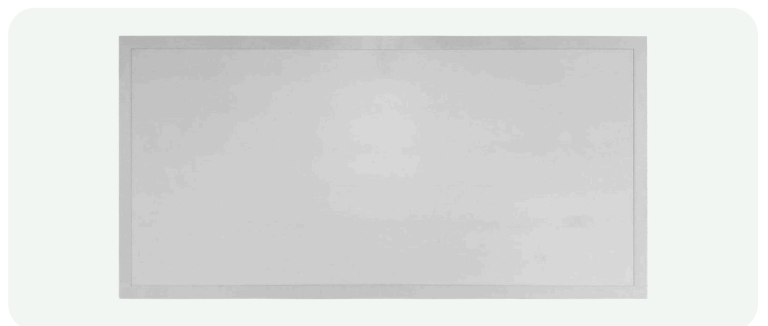

# LED Indoor Lighting Catalogue

 Since 2008

[aaled.ca](http://aaled.ca) | 416-493-6888 | [orderdesk@aaled.ca](mailto:orderdesk@aaled.ca)

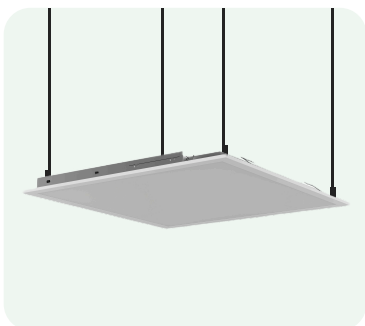
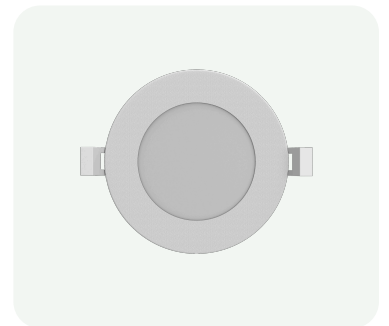

# LED Flat Panels



## Features

- Universal AC120-347V
- Multi-CCT
- Wattage Selectable
- Receptacle for Microwave Dimming Sensor (Sensor Sold Separately)
- Ultra-thin, Seamless Aluminum Frame
- Suitable for Damp Locations
- CRI>80
- Lifetime > 50,000 Hours
- DLC 5.1 P, UL&cUL Classified

## Applications

- |  |   |
|--|---|
|  Office Buildings |  Healthcare Facilities |
|  Schools          |  Retail Stores         |

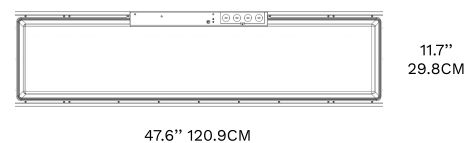
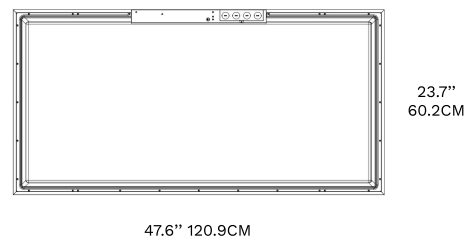
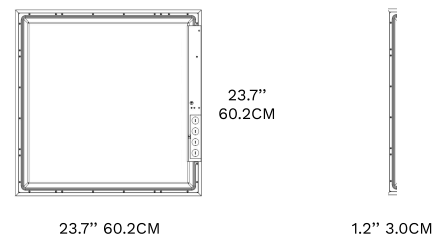

## Ordering Guide

SKU	Model	DLC Product ID	Voltage	Wattage	Efficacy	Lumens	CCT	Size
AA-500812UCCTW4-RC-LB	PL2X2UCCTW4	S-CNKV88	AC120-347	25/30/40	114	2750/3300/4400	3500/4000/5000K	2X2'
AA-500812UCCTW4-LB	PL2X2UCCTW4	S-CNKV88			3125/3750/5000			
AA-500814UCCTW4-RC-LB	PL1X4UCCTW4	S-CH7GFD	AC120-347	30/40/50	112	2750/3300/4400	3500/4000/5000K	1X4'
AA-500814UCCTW4-LB	PL1X4UCCTW4	S-CH7GFD			3125/3750/5000			
AA-500816UCCTW4-RC-LB	PL2X4UCCTW4	S-G5XYWF	AC120-347	30/40/50	115	3300/4400/5500	3500/4000/5000K	2X4'
AA-500816UCCTW4-LB	PL2X4UCCTW4	S-G5XYWF			125	3750/5000/6250		

### Warranty

10 Year Warranty. Extended Warranty Available.

### Installation

Suspension by cable. Mount by surface or frame kit.

## Accessories (Sold Separately)

### Suspension & Mounting Kits

SKU	Model	Description
AA-HangingKits	HangingKits	Suspension Kit
AA-900018-2X2-BL	900018-2X2-BL	Surface Mount Kit
AA-900018-2x2-FRAME	900018-2x2-FRAME	Drywall Frame Kit
AA-900018-1X4-BL	900018-1X4-BL	Surface Mount Kit
AA-900018-1x4-FRAME	900018-1x4-FRAME	Drywall Frame Kit
AA-900018-2X4-BL	900018-2X4-BL	Surface Mount Kit
AA-900018-2x4-FRAME	900018-2x4-FRAME	Drywall Frame Kit

### Sensors

SKU	Model	Description
AA-SENPIRBT-ANT1P4TBLE	ANT-1P4TBLE	PIR Bluetooth Sensor
AA-SENPIR-ANT1P4T	ANT1P4T	PIR Sensor

### Remotes & Drivers

SKU	Model	Description
AA-RC-100	RC-100	Remote Control
AA-EmergencyLEDDriver-Panel	YH34-08WL-51-0-X	LED Emergency Driver

# LED Basket Troffers



AA-900033U2



AA-900034U2-LB



AA-900035U2

## Features

- AC120-347V Wide Input
- Wattage Selectable
- 3 Selectable CCT: 3500K/4000K/5000K
- Easy to Install and Operate
- Receptacle for Microwave Dimming Sensor (Sensor Sold Separately)
- Suitable for Damp Location
- DLC 5.1 & cUL Listed
- Over 50,000 Hours Life Time

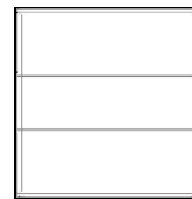

23.7" 60.3CM



2.1" 5.4CM

23.7" 60.3CM

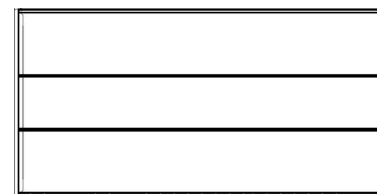

47.8" 121.3CM

23.7" 60.3CM

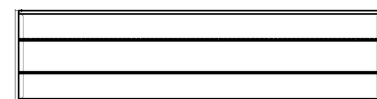

47.8" 121.3CM

11.7" 29.8CM

## Applications



Office Buildings



Healthcare Facilities



Schools



Retail Stores

## Ordering Guide

SKU	Model	DLC Product ID	Voltage	Wattage	Efficacy	Lumens	CCT	Size
AA-900033U	TR2X2UCCTW	S-TLXK4Q	120-347	25/30/40	130	2600/3250/3900	3500/4000/5000K	2X2'
AA-900033U2	TR2X2UCCTW							
AA-900034U-LB	TR2X4UCCTW	S-P571KM	120-347	34/42/50	135	4590/5670/6750	3500/4000/5000K	2X4'
AA-900034U2-LB	TR2X4UCCTW							
AA-900035U	TR1X4UCCTW	S-CUP5ZD	120-347	20/25/30	132	2640/3300/3960	3500/4000/5000K	1X4'
AA-900035U2	TR1X4UCCTW							

### Warranty

10 Year Warranty. Extended Warranty Available.

### Installation

Mount in drop or suspended ceilings with T-bars.

## Accessories (Sold Separately)

### Available Sensors

SKU	Model	Description
AA-SENPiRBT-ANT1P4TBLE	ANT-1P4TBLE	PIR Bluetooth Sensor
AA-SENPiR-ANT1P4T	ANT1P4T	PIR Sensor
AA-SENMW-ANT9C	ANT-9C	Microwave Dimming Sensor

### Available Remotes & Drivers

SKU	Model	Description
AA-RC-100	RC-100	Remote Control

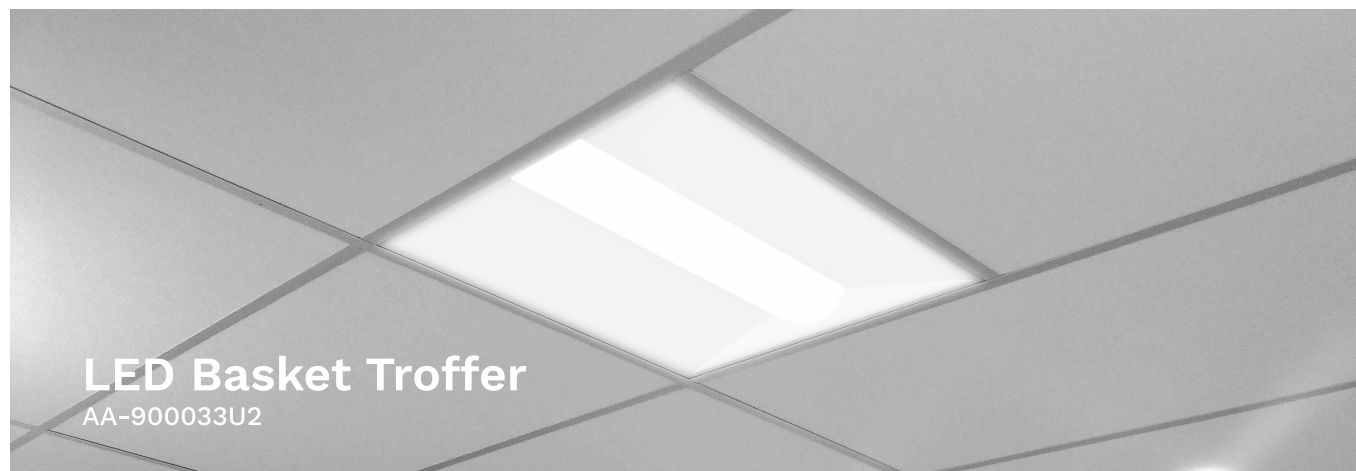

# LED Linear Strips



AA-900056UCCTW2A



AA-900055



AA-900085UCCTW

## Features

- Class 2 0-10V Dimming Driver, 4/6KV surge protector, w/overtemperature protection
- Wattage Selectable
- Color Temperature Selectable
- Optional Microwave Dimming Sensor
- Damp Location Rated
- DLC 5.1, cUL Listed
- L70: 150,000 hours

## Applications



Office Buildings



Healthcare Facilities



Schools



Retail Stores

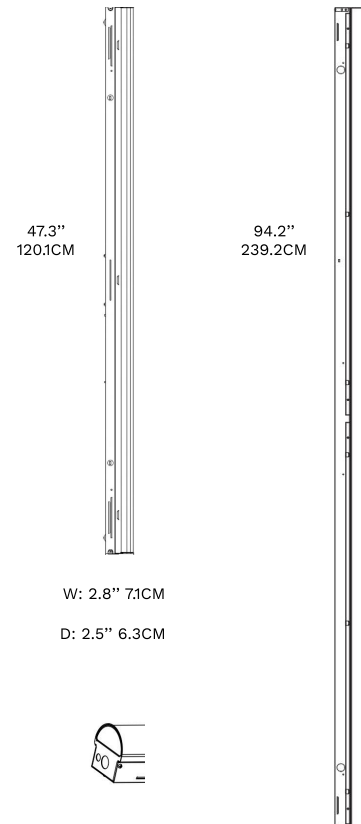

## Ordering Guide

SKU	Model	DLC Product ID	Voltage	Wattage	Efficacy	Lumens	CCT	Size
AA-900051UCCTW2	ST2FUCCTW2	S-LTLGYL	120-347	15/20/25	130	1950/2600/3250	3500 /4000 /5000K	24"
AA-900052UCCTW2	ST3FUCCTW2	S-58M4SV		18/25/30		2340/3250/3900		36"
AA-900056UCCTW2A	ST4FUCCTW2	S-TU4D51		34/38/45	134	4420/4940/6126		48"
AA-900059UCCTW2A	ST8FUCCTW2	S-0MDG1P		65/75/90		8450/9750/12150		96"
AA-900051	ST2F20WUNV40K	PLM11DR9LK35	120-277	20	131	2600	4000K	24"
AA-900054	ST4F18WUNV50K	PLA2K9M6SIAV		18	132	2376	5000K	48"
AA-900055	ST4F35WUNV35K	PLJ3GD8X9DFZ		35	131	4585	3500K	
AA-900058	ST8F38WUNV40K	PLDBWQMMXJKH		38	133	5054	4000K	96"
AA-900061	ST4F32W347V40K	PLIOBYU9BJHY	347V	32	132	4224	5000K	48"
AA-900062	ST4F32W347V50K	PLKW2FUC5P8B			134	4288		5000K
AA-900063	ST8F65W347V40K	PLG6RE8JRJ6F		65	132	8580	4000K	96"
AA-900064	ST8F65W347V50K	PLA2K9M6SIAV			134	8450	5000K	
AA-900085UCCTW	WR4FTUCCTW	S-YGL4TY	120-347	32/40/48	123	3936/4920/5904	3500/4000 /5000K	48"

### Warranty

10 Year Warranty. Extended Warranty Available.

### Installation

Suspension or surface mounted.

## Accessories (Sold Separately)

### Available Sensors, Remotes, & Drivers

SKU	Model	Description
AA-SENPIRAC120347VOF	BRI819P-C-O	PIR Occupancy Sensor
AA-SENPIRAC120347VD	BRI819P-C-D	PIR Occupancy Sensor
AA-SENMW-ANT3A	ANT-3A	Microwave Dimming Sensor
AA-SENMW-ANT3C	ANT3C	Microwave Dimming Sensor
AA-RC-100	RC-100	Remote Control
AA-EmergencyLEDDriver-Strip	YH28-08WL-50	LED Emergency Driver

### Available Parts

SKU	Model	Description
AA-STBRK	STBRK	Strip Connector Bracket
AA-Endcap-900085UCCTW	Endcap-900085UCCTW	LED Wraparound Endcap
AA-900085UCCTW-BRACKET	900085UCCTW-BRACKET	LED Wraparound Bracket

# LED Architectural Strips



## Features

- Class 2 0-10V Dimming Driver, 4/6KV surge protector, w/overtemperature protection
- Direct/indirect light distribution (70% direct, 30% indirect)
- Various connection options
- Damp location rated
- CRI: >80
- 0-10V continuous dimming
- DLC 5.1, cUL Listed.
- L70: 100,000 Hours

## Applications



Office Buildings



Healthcare Facilities



Schools



Retail Stores

47.6"  
121CM

94.3"  
241.8CM

H: 3.2"  
8.2CM

W: 2.8"  
7.1CM

## Ordering Guide

SKU	Model	DLC Product ID	Voltage	Wattage	Efficacy	Lumens	CCT	Size
AA-900081UCCTW-DI-B-LB	AL4FTUCCTW-DI-B	S-SZSWZD	120-347	35/40/45	120	4200/4800/5400	3000 /3500 /4000K	48"
AA-900081UCCTW-DI-W-LB	AL4FTUCCTW-DI-W	S-SZSWZD						
AA-900082UCCTW-D-B-LB	AL4FTUCCTW-D-B	S-B5QVKQ						
AA-900082UCCTW-D-W-LB	AL4FTUCCTW-D-W	S-B5QVKQ						
AA-900083UCCTW-DI-B-HB	AL8FTUCCTW-DI-B	S-XC1T39		60/75/90	7200/9000/10800	96"		
AA-900083UCCTW-DI-W-HB	AL8FTUCCTW-DI-W	S-XC1T39						
AA-900084UCCTW-D-B-LB	AL8FTUCCTW-D-B	S-47K0MM						
AA-900084UCCTW-D-W-LB	AL8FTUCCTW-D-W	S-47K0MM						

### Warranty

10 Year Warranty. Extended Warranty Available.

### Installation

Surface mounted or chain suspended. Various connectors Available.

## Accessories (Sold Separately)

### Available Suspension & Mounting Kits

SKU	Model	Description
AA-ASTP-SMK	ASTP-SMK	Surface Mounting Kit For 2.8" Housing
AA-ASTP-WallMountingKit	ASTP-WallMountingKit	Wall Mounting Kit For 2.8" Housing
AA-ASTP-SuspensionKit	ASTP-SuspensionKit	Suspension Kit, Black Finish
AA-ASTP-SuspensionKit	ASTP-SuspensionKit	Suspension Kit, White Finish
AA-ASTP-RecessedMounting-4F	ASTP-RecessedMounting-4F	Recessed Mounting Kit For 4FT
AA-ASTP-RecessedMounting-8F	ASTP-RecessedMounting-8F	Recessed Mounting Kit For 8FT
AA-ASTP-10F600VB	ASTP-10F600VB	10FT 600V Leads W/Quick Connector, Black
AA-ASTP-10F600VW	ASTP-10F600VW	10FT 600V Leads W/Quick Connector, White

### Available Parts

SKU	Model	Description
AA-ASTP-I Connector	ASTP-I Connector	"I" Connector For 2.8" Housing
AA-ASTP-L Connector	ASTP-L Connector	"L" Connector For 2.8" Housing
AA-ASTP-T Connector	ASTP-T Connector	"T" Connector For 2.8" Housing
AA-ASTP-+' Connector	ASTP-+' Connector	"+" Connector For 2.8" Housing

Our LED Architectural Strips suit any commercial space. Express creativity with 8 different mounting & connection options.

# LED Linear High Bays

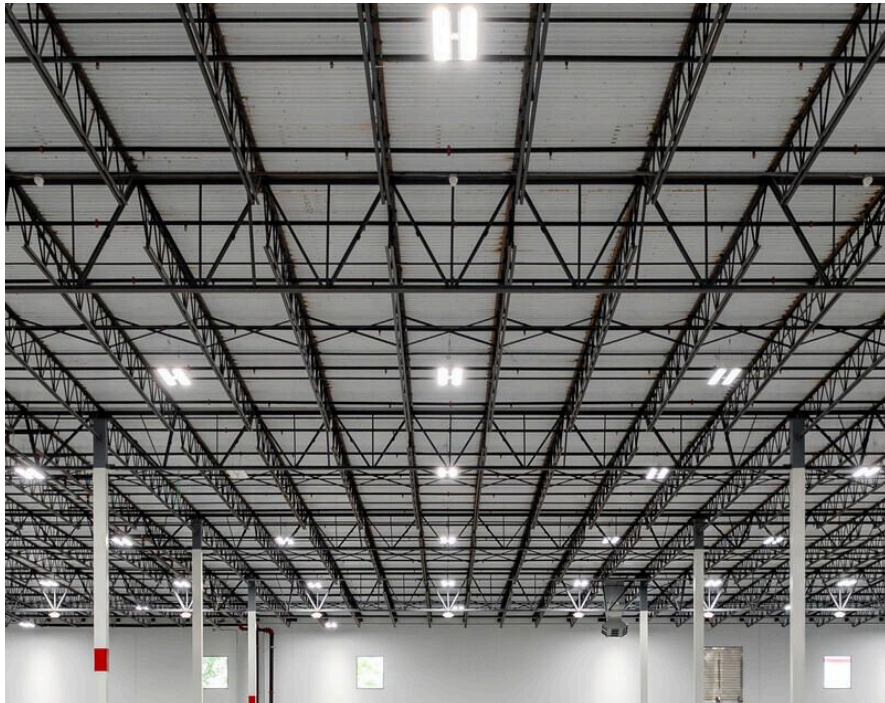

AA-900025U-DC12V



AA-900073U

## Features

- AC120-347V
- Class 2 0-10V Dimming Driver, 4/6KV surge protector, w/overtemperature protection
- L70: 100,000 hours
- Receptacle for Microwave Dimming Sensor (Sensor Sold Separately)
- Mounting V-Hooks provided
- Optional pendant mount
- Damp location rated
- CRI: >80



L: 23.8" 60.5CM W: 12.9" 33CM  
D: 3.6" 9.2CM

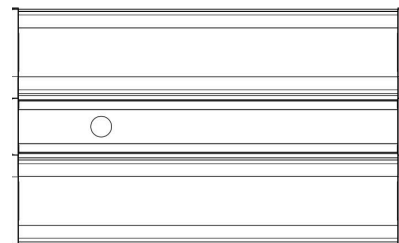

L: 24.8" 62.9CM  
W: 15.75" 40CM D: 1.65" 4.1CM

## Applications



Office Buildings



Healthcare Facilities



Schools



Retail Stores

## Ordering Guide

SKU	Model	DLC Product ID	Voltage	Wattage	Efficacy	Lumens	CCT	Size
AA-900031U	AALHBP105W4KF120347V	PLRZN9G615NL	120 - 347	105	135	14175	4000K	24"
AA-900025U-DC12V	AALHBP155W5KF120347V	P8VRB2AM		155	136	21102	5000K	
AA-900073U	LHBSL110W5KF120347V	S-91583W		110	140	15659	4000K	24"
AA-900074U	LHBSL110W4KF120347V	S-04U8VX		135	15209	4000K		
AA-900075U	LHBSL160W5KF120347V	S-EU96P0		160	141	22474	5000K	
AA-900076U	LHBSL160W4KF120347V	S-C9Z7E2			137	22000	4000K	
AA-900079U	LHBSL320W5KF120347V	S-OPXNMR		320	141	44645	5000K	48"

### Warranty

10 Year Warranty. Extended Warranty Available.

### Installation

Surface mounted or chain suspended.

## Accessories (Sold Separately)

### Available Suspension & Mounting Kits

SKU	Model	Description
AA-LHPMKIT	LHPMKIT	Pendant Mount
AA-LHPSMKIT2	LHPSMKIT2	Surface Mounting Kit

### Available Sensors, Remotes, & Drivers

SKU	Model	Description
AA-HD06VCRH3	HD06VCRH3	Microwave Sensor
AA-SENPIR-ANT4D	ANT-4D	PIR Sensor
AA-RC-HD06VCHR3	RC-HD06VCHR3	Remote Control
AA-RC-100	RC-100	Remote Control
AA-BP-AL96H2000-03-63	BP-AL96H2000-03-63	Constant Current Driver
AA-EmergencyLEDDriver-LHB	YH29-24WL-50	LED Emergency Driver

### Available Parts

SKU	Model	Description
AA-LHWG	LHWG	Wireguard
AA-LHBFL	LHBFL	Frosted Lens

Our LED Linear High Bays are perfect for applications with high ceilings. Ensure your facilities are bright and efficient by pairing our fixtures with PIR sensors, or emergency-proof your lighting with our Emergency LED Drivers.

# LED Linear High Bays



AA-900073UCCTW



AA-900075UCCTW



AA-900077UCCTW



AA-900079UCCTW

## Features

- AC120-347V
- Class 2 0-10V Dimming Driver, 4/6KV surge protector, w/overtemperature protection
- L70: 100,000 hours
- Receptacle for Microwave Dimming Sensor (Sensor Sold Separately)
- Mounting V-Hooks provided
- Optional pendant mount
- Damp location rated
- CRI: >80

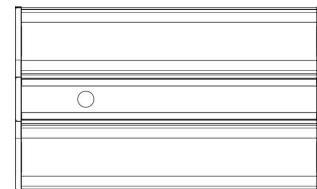

L: 16.5" 42CM  
 L: 22.8" 58CM  
 L: 31.2" 79CM  
 W: 10.2" 26CM D: 1.77" 4.5CM

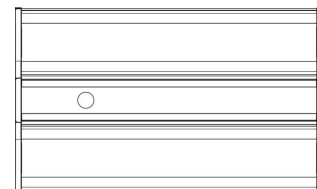

L: 24.8" 62.9CM W: 15.75" 40CM  
 D: 1.65" 11.8CM

## Applications



Office Buildings



Healthcare Facilities



Schools



Retail Stores

## Ordering Guide

SKU	Model	DLC Product ID	Voltage	Wattage	Efficacy	Lumens	CCT	Size
AA-900073UCCTW	LHBSL92WUCCTW	S-UZ7NKY		78/92/115		11700/13650/17250		16.8"
AA-900075UCCTW	LHBSL155WUCCTW	S-OJLH1G	120	135/155/185	155	20250/23250/27750	4000	22.8"
AA-900077UCCTW	LHBSL230WUCCTW	S-0NGXQE	347	200/230/270		30000/34500/40500	/5000K	31.2"
AA-900079UCCTW	LHBSL340WUCCTW	LHBSL340W		270/340/400	150	40500/51000/60000		44.1"

### Warranty

10 Year Warranty. Extended Warranty Available.

### Installation

Surface mounted or chain suspended.

## Accessories (Sold Separately)

### Available Suspension & Mounting Kits

SKU	Model	Description
AA-LHPMKIT	LHPMKIT	Pendant Mount
AA-LHPSMKIT2	LHPSMKIT2	Surface Mounting Kit

### Available Sensors, Remotes, & Drivers

SKU	Model	Description
AA-HD06VCRH3	HD06VCRH3	Microwave Sensor
AA-SENPIR-ANT4D	ANT-4D	PIR Sensor
AA-RC-HD06VCHR3	RC-HD06VCHR3	Remote Control
AA-RC-100	RC-100	Remote Control
AA-BP-AL96H2000-03-63	BP-AL96H2000-03-63	Constant Current Driver
AA-EmergencyLEDDriver-LHB	YH29-24WL-50	LED Emergency Driver

### Available Parts

SKU	Model	Description
AA-LHWG	LHWG	Wireguard
AA-LHBFL	LHBFL	Frosted Lens

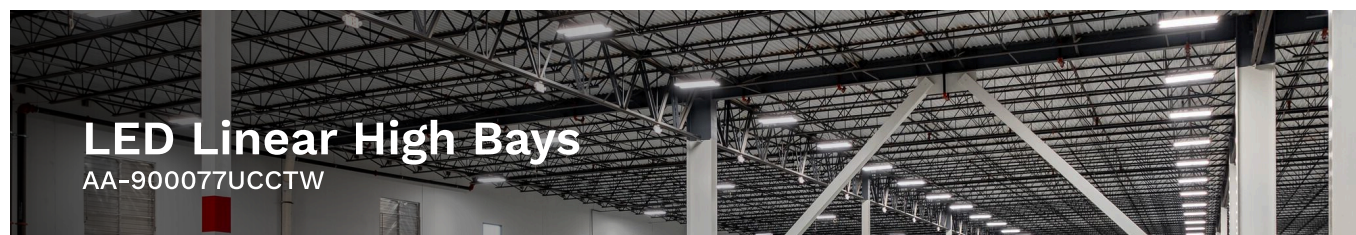

**LED Linear High Bays**

AA-900077UCCTW

# LED Vapour Tights



AA-900077UCCTWVP2



AA-900015UCCTW4FT2A



AA-900015UCCTW8FT2A



AA-900015UCCTW2FT

## Features

- AC120-347V
- Class 2 0-10V Dimming Driver, 4/6KV surge protector, w/overtemperature protection
- L70: 100,000 hours
- Receptacle for Microwave Dimming Sensor (Sensor Sold Separately)
- Damp location rated
- IP65, IP67, Rated
- IK10 rated,
- NEMA, NSF Certified

## Applications



Office Buildings



Healthcare Facilities



Parking Garages



Manufacturing

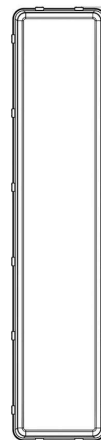

L: 47.5" 120.6CM  
W: 10.4" 26.4CM  
D: 4.5" 11.4CM

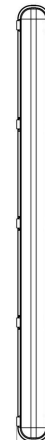

L: 23.5" 60CM | 47.2" 119.8CM  
W: 3.8" 9.6CM | 5" 12.7CM  
D: 3.1" 7.8CM



L: 94.5" 240CM  
W: 3.8" 9.6CM | 5" 12.7CM  
D: 3.1" 7.8CM

## Ordering Guide

SKU	Model	DLC Product ID	Voltage	Wattage	Efficacy	Lumens	CCT	Size
AA-900015UCCTW4FTA	VP4FTUCCTW	S-7KML5V		34/38/45	132	4420/4940/5850		
AA-900015UCCTW4FT2A	VP4FTUCCTW2	S-6R88V0		26/35/45	142	3640/4900/6390		48"
AA-900077UCCTWVP2	LHBVP155WUCCTW	S-N12TF5	120	155/185/200	160	24800/29600/32000	3500 /4000 /5000K	
AA-900015UCCTW8FTA	VP8FTUCCTW	S-680N2L	347	65/75/90	140	8450/9750/11700		96"
AA-900015UCCTW8FT2A	VP8FTUCCTW2	S-Z5X2RG		65/75/90	132	9100/10500/12870		
AA-900015UCCTW2FT	VP2FTUCCTW	S-ECM09R		15/20/25	130	2340/3250/3900		24"

### Warranty

10 Year Warranty. Extended Warranty Available.

### Installation

Surface mount. Wire Guard available.

## Accessories (Sold Separately)

### Available Sensors, Remotes, & Drivers

SKU	Model	Description
AA-SENMW-ANT3C	ANT-3C	Microwave Dimming Sensor
AA-SENMW-ANT3A	ANT3A	Microwave Dimming Sensor
AA-RC-100	RC-100	Remote Control

### Available Parts

SKU	Model	Description
AA-LHWG-900077UCCTW	LHWG-900077UCCTW	Wireguard



# LED Flush Mount/Vanity Lights



AA-900088CCT-BL



AA-900089CCT-BN



AA-900090CCT

## Features

- Energy Star, cETL Listed
- Efficacy: 80LM/W
- CRI: >80
- Power Factor: >0.9
- Optional Built-in Microwave dimming sensor
- Remote control functions
- Easy to install and operate
- 10 Year Warranty

4"  
10.2CM



24"  
60CM

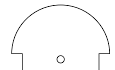

3.6"  
9.2CM

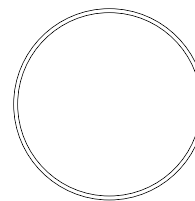

12"  
30.4CM

16"  
40.6CM



2.3"  
6CM

## Applications



Office Buildings



Residential Buildings



Schools



Retail Stores

## Ordering Guide

SKU	Model	Energy Star ID	Voltage	Wattage	Efficacy	Lumens	CCT	Size
AA-900086CCT-BL	FM16IN35WCCT	2485668		35		2800		16"
AA-900087CCT-BN	FM16IN35WCCT	2485668		35		2800		16"
AA-900088CCT-BL	FM12IN18WCCT	2485667		18		1440		12"
AA-900089CCT-BN	FM12IN18WCCT	2485667		18		1440	2700 /3000 /3500 /4000 /5000K	12"
AA-900086CCT-BL-NS	FM16IN35WCCT	2485668	120	35	80	2800		16"
AA-900087CCT-BN-NS	FM16IN35WCCT	2485668		35		2800		16"
AA-900088CCT-BL-NS	FM12IN18WCCT	2485667		18		1440		12"
AA-900089CCT-BN-NS	FM12IN18WCCT	2485667		18		1440		12"
AA-900090CCT	VN2F25WCCT	2485666		25		2000	3000/4000/5000K	24"

### Warranty

10 Year Warranty. Extended Warranty Available.

### Installation

Surface mount on low ceiling heights.

## Accessories (Sold Separately)

### Available Remotes

SKU	Model	Description
AA-RC106	RC106	RC For Flush Mount

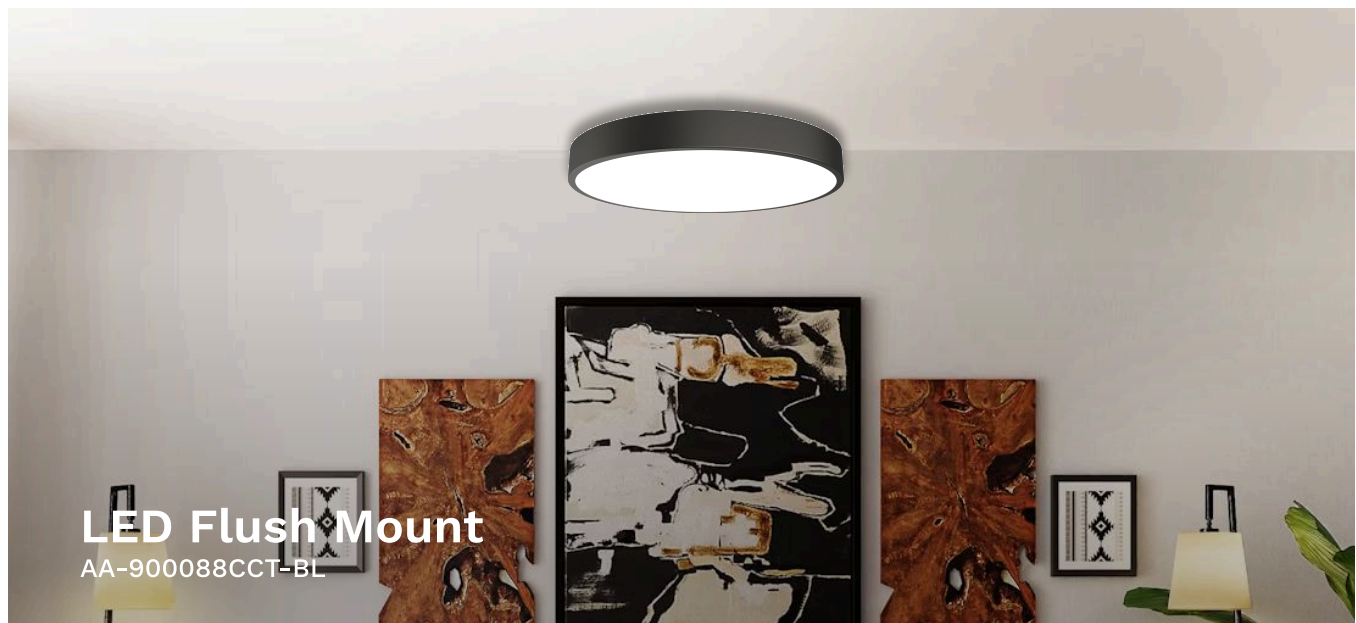

# LED UFO High Bays



AA-900045UCCTW2



AA-900045UCCTW-WHITE



AA-900068UCCTW

## Features

- Receptacle for Microwave Dimming Sensor (Sensor Sold Separately)
- DLC 5.1 Premium Listed
- Stylish and modern profile
- 90 degree reflector available
- 0-10V Dimming
- Fully weather proof
- Class 2 0-10V Dimming Driver
- 6kV Surge Protector
- NSF Certified
- IP65, resistant to vibration

8.2" 20.2CM  
8.6" 21.8CM  
7.3" 18.5CM

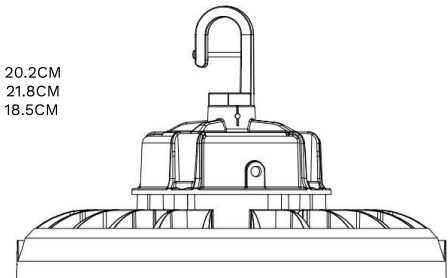

11.8" 29.9CM  
13.9" 35.3CM  
15.1" 38.3CM

## Applications



Garages



Recreational Centers



Warehouses



Retail Stores

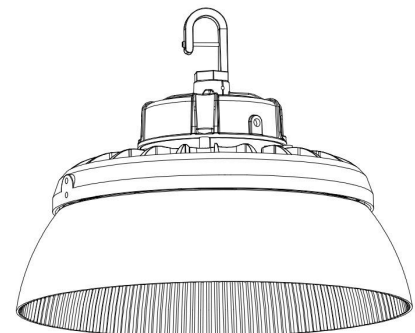

## Ordering Guide

SKU	Model	DLC Product ID	Voltage	Wattage	Efficacy	Lumens	CCT	Size
AA-900045U	HBU150W120347V50K	S-A9TZLD	120	150	150	21000	5000K	13 X 6.3"
AA-900045UCCTW2	HBU150WUCCTW2	S-A5J2DF		85/120/150		12325/17400/21750		11.8 x 8.2"
AA-900045UCCTW-WHITE	HBU150WUCCTW2	S-YT0X68	347	140/190/240	145	12325/17400/21750	3000 /4000 /5000K	13.9 x 8.6"
AA-900067UCCTW2	HBU240WUCCTW2	S-7KZMZB				22400/30400/38400		
AA-900067UCCTW2-WHITE	HBU240WUCCTW2	S-7KZMZB	347	140/190/240	145	20300/27550/34800	3000 /4000 /5000K	13.9 x 8.6"
AA-900068UCCTW	HBU320WUCCTW	HBU320W				240/280/320		

### Warranty

10 Year Warranty. Extended Warranty Available.

### Installation

Suspension by cable. Reflectors available.

## Accessories (Sold Separately)

### Available Sensors, Remotes, & Drivers

SKU	Model	Description
AA-HBUMCSENSOR-DC12V	ANT-5-4T	Microwave Sensor
AA-RC-100	RC-100	Remote Control
AA-BP-AL96H2000-03-63	BP-AL96H2000-03-63	Constant Current LED Driver

### Available Parts

SKU	Model	Description
AA-HBUREFLECTOR-900045UCCTW	HBUREFLECTOR-900045UCCTW	90 Degree Reflector
AA-HBUREFLECTOR-900045UCCTW2	HBUREFLECTOR-900045UCCTW2	90 Degree Reflector
AA-HBUREFLECTOR-900067UCCTW	HBUREFLECTOR-900067UCCTW	90 Degree Reflector
AA-HUBREFLECTOR-32	HUBREFLECTOR-32	90 Degree Reflector 320mm
AA-HUBREFLECTOR-36	HUBREFLECTOR-36	90 Degree Reflector 360mm
AA-900059-UFO	900059-UFO	Optional U-Bracket Mount
AA-UFOGW-150W	UFOGW-150W	Wire Guard For UFO 150W
AA-UFOGW-240W	UFOGW-240W	Wire Guard For UFO 240W
AA-UFOLENS-150W	UFOLENS-150W	120 Degree Frosted Lens

Our LED UFO High Bays are perfect for applications with high ceilings. Ensure your facilities are bright and efficient by pairing our fixtures with microwave sensors, or tailor a custom safety solution with reflectors and wire guards.

# LED Canopy Lights

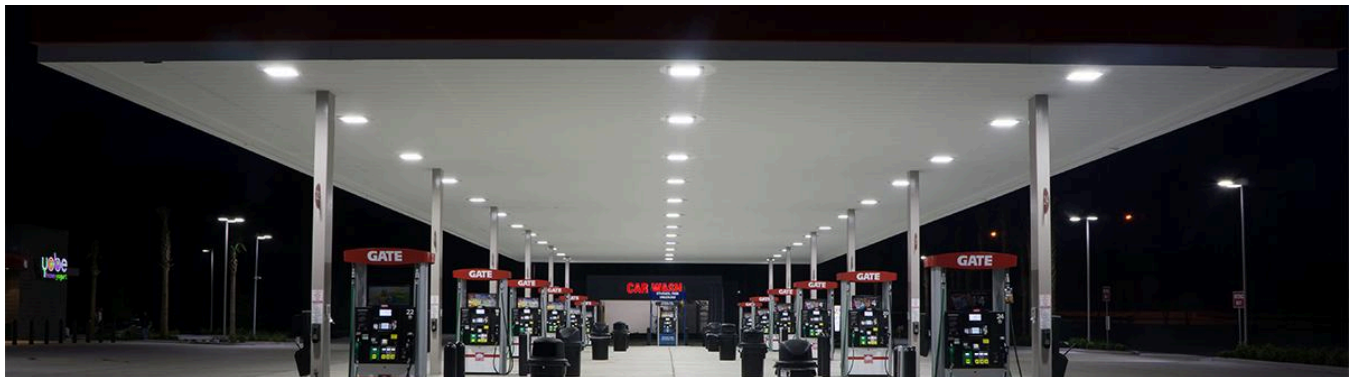

AA-700034H



AA-700034N



AA-700035UCCTW



AA-700035UCCTW-BK

## Features

- ETL, DLC 5.1 Premium listed
- CCT tunable available
- Wattage tunable available
- Microwave motion, photocell sensor optional
- Unique design, strong extruded lamp body
- Lifespan: >50,000Hrs
- 10 year warranty, extended warranty available

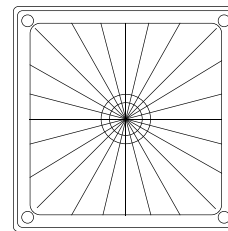

9.5"  
24.3CM

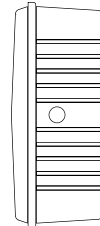

2.8"  
7.3CM

## Applications



Garages



Recreational Centers



Warehouses



Retail Stores

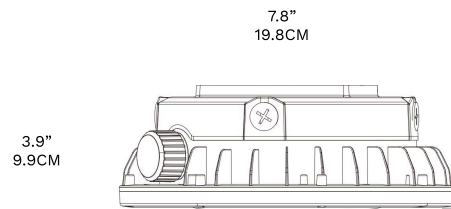

3.9"  
9.9CM

7.8"  
19.8CM

10.2"  
25.9CM

## Ordering Guide

SKU	Model	DLC Product ID	Voltage	Wattage	Efficacy	Lumens	CCT	Size
AA-700034H	CP50W347V5K	PLY7IYUAP51W	120-347	45	134	5255	5000K	10 X 10 X 4.1"
AA-700034-4K	CP40WUNV40K	PLGI2OHDTSQ2	120-277	40	130	5092	4000K	
AA-700034N	CP40WUNV50K	PLY7IYUAP51W			134	4800	5000K	
AA-700035-4K	CP70WUNV40K	PL4I8M1CIS8I	347-480	70	130	8400	4000K	
AA-700035H-4K	CP70W34740K	PL9IDSM9CIYK			120			
AA-700035UCCTW	CP02A-75MW-50KMC-MV-D-V40	S-YHRNQ4	120-347	40/50 /60/75	135	6750/8100 /10,800/13,500	3000/4000/5000K	10.2 X 7.8 X 4.0"
AA-700035UCCTW-BK	CP02A-75MW-50KMC-MV-D-V40							

### Warranty

10 Year Warranty. Extended Warranty Available.

### Installation

Surface mount.

## Accessories (Sold Separately)

### Available Sensors

SKU	Model	Description
AA-HBUMCSENSOR-DC12V	ANT-5-4T	Microwave Sensor



**LED Canopy Lights**  
AA-700035UCCTW

# LED Type A/B Tubes



## Features

- LED T8 Type A
  - Compatible with instant & programmed start ballast
  - Works with IS+PS+RS+EM
- LED T5 Type B bypass
  - Single & double end input
  - Triac dimming @ 120V
- High Lumen Efficiency
- Suitable for damp locations
- Lifetime: 50,000 Hours
- DLC & cUL Listed

## Applications

- Office Buildings
- Commercial Lighting
- Schools
- Retail Stores

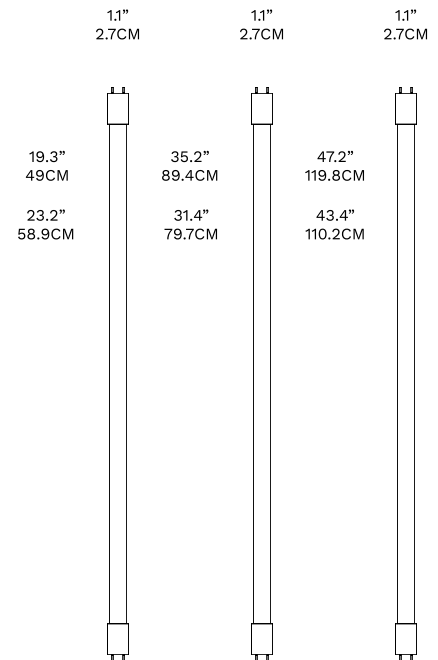

## Ordering Guide

### Type A Tubes

SKU	Model	DLC Product ID	Voltage	Wattage	Efficacy	Lumens	CCT	Size
AA-600040	T8L-IDDM13-1250-2ft-ECA-91	PQ6K0AU3	Works With AC110 /277 /347 /480V Electronic Ballasts	9	120	1150	5000K	24"
AA-600043	T8L-IDDM13-1450-3ft-EBA-90	PQ6K0AU3		12	121	1450		36"
AA-600033-SP	T8L-IDDM13-1800-4FT-CBA-91	P56Q4FK9		11.5	128	1800	4000K	48"
AA-600034	KK-T8-4EW-14-5AAD	PD182D6R		14.5	134	1780	5000K	
AA-600036CCT	CH1128CT-48-13W 83065-07	S-OWTAMF		16	131	2100	3000/3500 /4000/5000/6500K	48"
AA-600036-SP	T8U-IDDM13-2200-L-CBA	PAQMGMB7		15	126	2200	4000K	
AA-600037-SP	T8U-IDDM13-2200-L-EBA	P5SPFY74		120	12	1800	5000K	48"
AA-600046	T8L-IDDM11-1600-4ft-EBA	PASFHRYF						
AA-600054-2B	T5L-IDDM14-3200-4FT-EBA	P2X3LEJS	25		3500			

### Type B Tubes

SKU	Model	DLC Product ID	Voltage	Wattage	Efficacy	Lumens	CCT	Size
AA-600602UCCT	CH1172HT-36-12W 83550-07	S-PB2DHM	120-347	12	120	1500-1600	3500 /4000 /5000K	36"
AA-600618UCCT	CH1172HT-48-15W 83550-07	S-5LSKQG		15	140	2000-2200		48"
AA-600622UCCT	CH1172HT-48-11.5W 83550-07	S-91CXFI		11.5	152	1650-1800	5000K	
AA-600054U-TYPEB	CH1192H-46-25W 850-1	S-NP2IOV		25	140	3400		

#### Warranty

10 Year Warranty. Extended Warranty Available.

#### Installation

Ballast compatible. G13 Socket. Direct wire/bypass.

Our LED Type A and Type B T5 and T8 tubes are great, high efficiency replacement options for typical fluorescent bulbs. Select tubes are also eligible for instant rebates! Contact us for more information on eligible products.

# LED Running Man Exit Signs

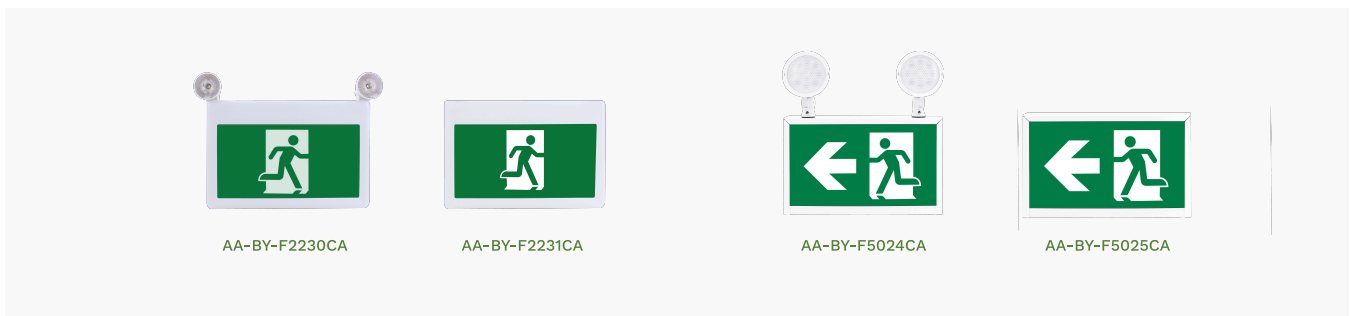

## Features

- Innovative, easy installation in minutes
- Easy replacement pictogram design
- Emergency Duration: 1.5-2 Hours
- Charging Time: 24 Hours
- Battery: NiCd 3.6V/600/900/1200mAH
- Cover/Housing Materials: PC/ABS
- Mounting Type: Wall /Ceiling /Side
- Operation Temperature: 0°C - 40°C
- Damp Locations
- cULus Listed, ROHS
- 10 Year Warranty

## Applications



Office Buildings



Commercial Lighting



Schools



Retail Stores

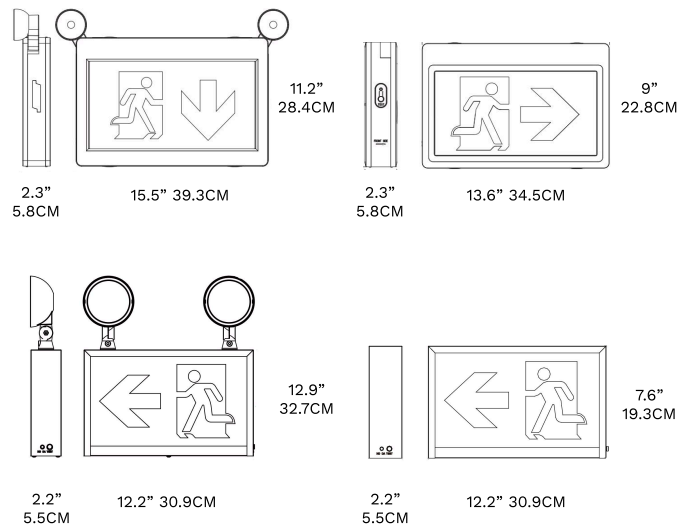

Ordering Guide

SKU	Model	Voltage	Wattage	CCT	Battery	Size
AA-BY-F2230CA	BY-F2230CA		4.5	6500K	Ni-Cd 3.6V 900mAh	15.5 x 11.2 x 2.3"
AA-BY-F2231CA	BY-F2231CA		4.5	6500K	Ni-Cd 3.6V 900mAh	13.6 x 9 x 2.3"
AA-BY-F5024CA	BY-F5024CA	120-347	4	6500K	Ni-Cd 3.6V 1200mAh	12.2 x 12.9 x 2.2"
AA-BY-F5025CA	BY-F5025CA		4	6500K	Ni-Cd 3.6V 600mAh	12.2 x 7.6 x 2.2"
AA-RunningmanExitCombo	CET-180		2 x 1.2	6000K	3.6V Nickel Cadmium Battery	13.5 x 9 x 2"

Warranty

10 Year Warranty. Extended Warranty Available.

Installation

Surface mount.

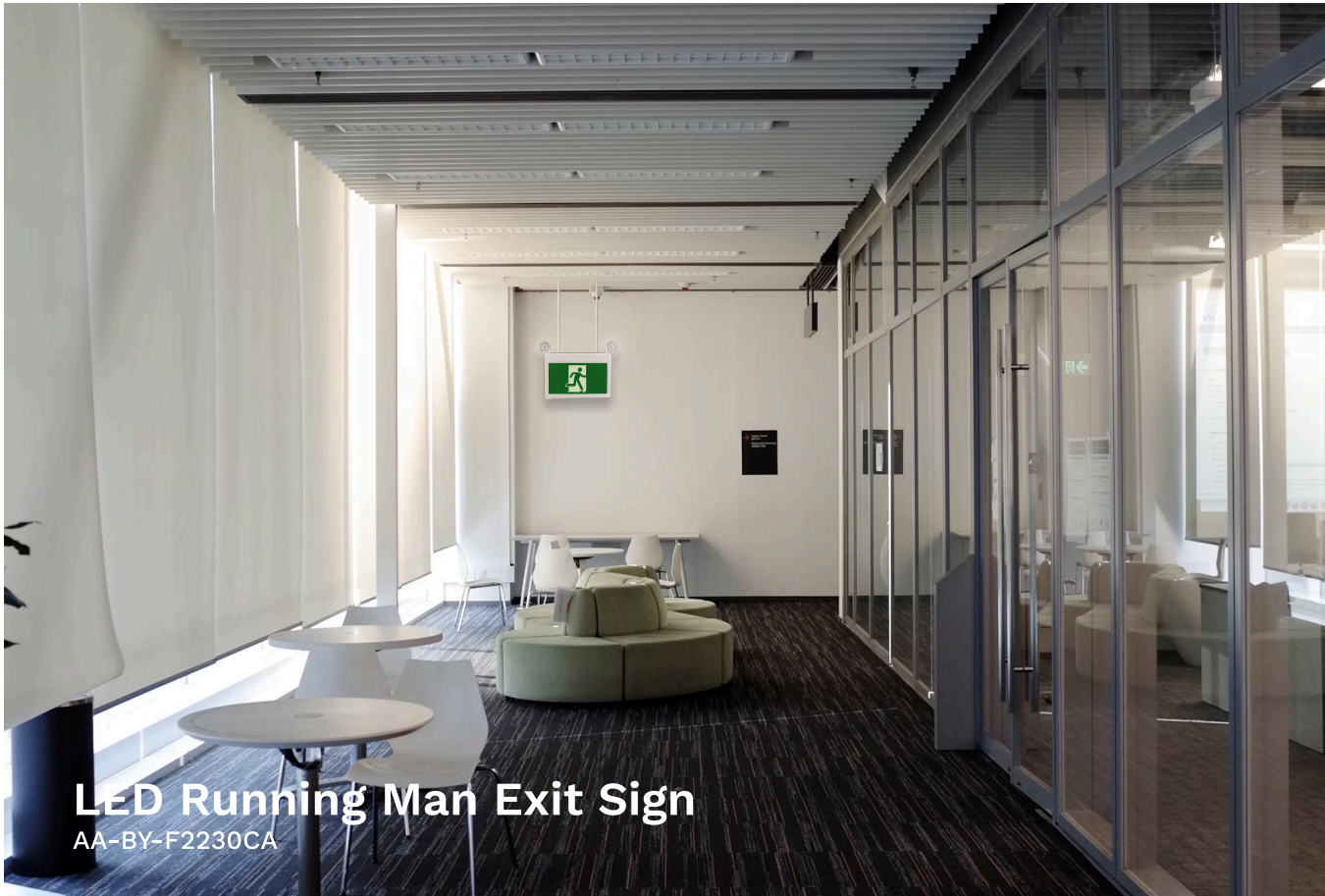

**LED Running Man Exit Sign**  
AA-BY-F2230CA

# Remote Capable Steel Battery Units

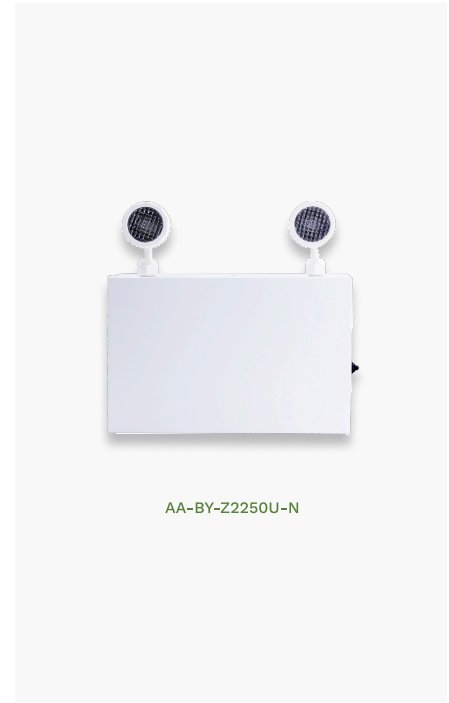

## Features

- Universal Input: AC120V/277V/347V
- Remote Capable: 72W | 150W - 30mins
- CCT: 6000K
- Operation Temperature: 10°C - 40°C
- Charging Time: 24 Hours
- Lamp Power: 2x2W; 2x130LM
- Battery: Lead Acid Battery 12V 7Ah | 6V 12Ah - 2PCS
- Cover/Housing Materials: PMMA/ABS+Iron
- Mounting Type: Wall/End Mounting
- cULus Listed

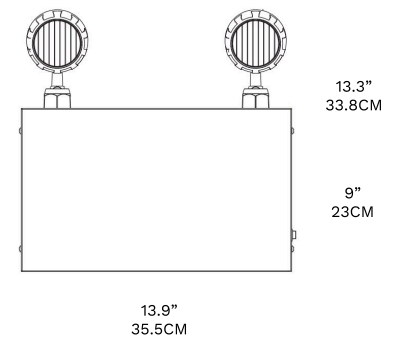

## Applications

- |  |   |
|--|---|
|  Office Buildings |  Commercial Lighting |
|  Schools          |  Retail Stores       |

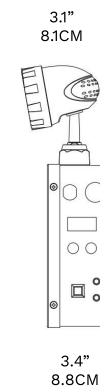

Ordering Guide

SKU	Model	Voltage	Voltage	CCT	Battery/Lumens	Size
AA-BY-Z2250U-N	BY-Z2250U-N	120-347	150W at 30 Minutes	6000K	2x6 12.0Ah Lead Acid Battery	14 x 13.3 x 3.5"
AA-BY-Z22172U-N	BY-Z22172U-N		72W at 30 Minutes		12V 7.0Ah Lead Acid Battery	

Warranty

10 Year Warranty. Extended Warranty Available.

Installation

Surface mount.



**Remote Capable Steel Battery Unit**  
AA-BY-Z2250U-N

# LED Remote Lamp Heads

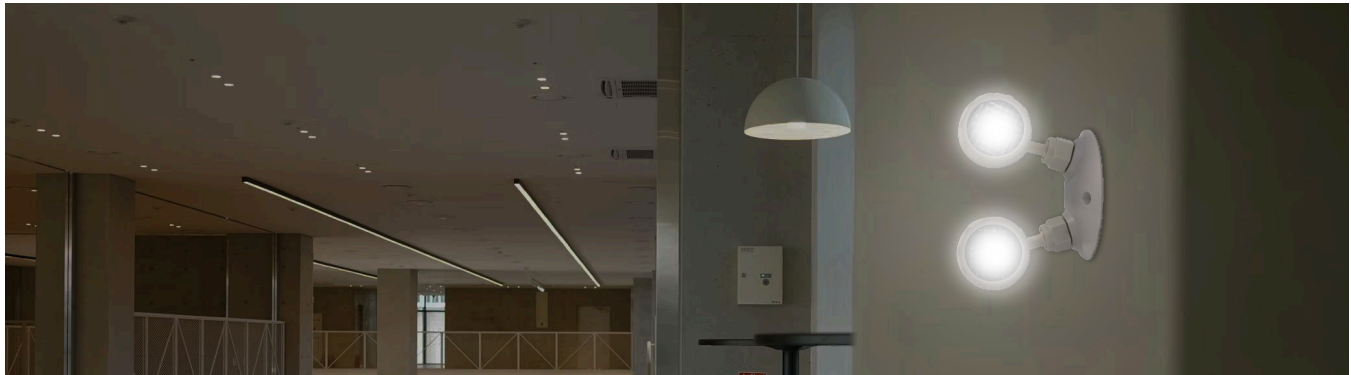

AA-BY-Z1101U



AA-BY-Z1102U

## Features

- Input Voltage: DC 3.6V-24V
- Operation Temperature: 0°C-40°C
- Correlated Color Temperature: 6000K
- Max. mounting height: 10.8 ft (3.2 m) | 13.8 ft (4.1 m)
- Weight: 0.15kg | 0.26kg
- 10 Year Warranty

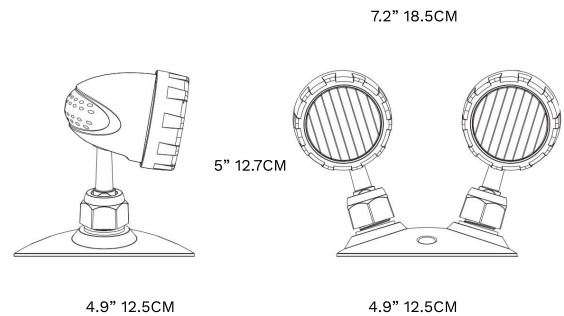
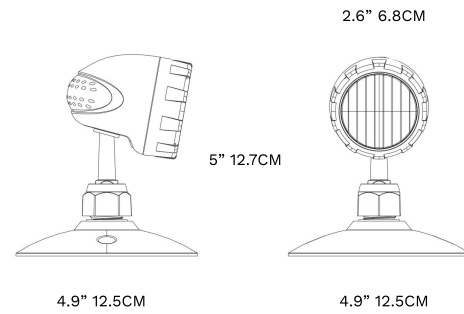

## Applications



Office Buildings



Commercial Lighting



Schools



Retail Stores

## Ordering Guide

SKU	Model	Voltage	Wattage	CCT	Battery/Lumens	Size
AA-BY-Z1101U	BY-Z1101U	DC3.6V-DC24V	1 x 2W	6000K	1 x 130 LM	5 x 4.9 x 4.9"
AA-BY-Z1102U	BY-Z1102U	DC5V-DC24V	2 x 5W		2 x 350 LM	7.3 x 4.9 x 4.9"

### Warranty

10 Year Warranty. Extended Warranty Available.

### Installation

Surface mount.



## LED Remote Lamp Heads

AA-BY-Z1102U

# LED Remote Head Lights



AA-BY-Z4430U



AA-BY-Z3625U



AA-BY-Z3125E

## Features

- Emergency Run Time: 90 Minutes | 120 Minutes
- Recharge Time: 24 Hours
- Battery: Ni-Cd 3.6V, 900mAh | 1200mAh
- Emergency Luminance Flux: 180LM
- Correlated Color Temperature: 6000K | 6000K-7000K
- Max. mounting height: 21.6ft (6.5m) | 16.2 ft (4.9 m) | 10.4ft (3.1 m)
- Operation Temperature: 0°C-40°C
- Weight: 0.60kg

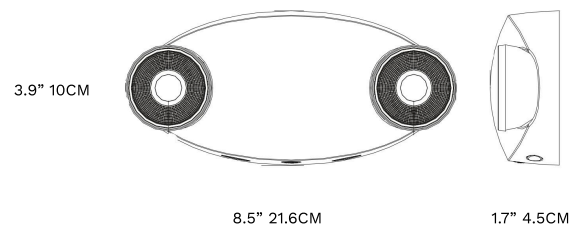
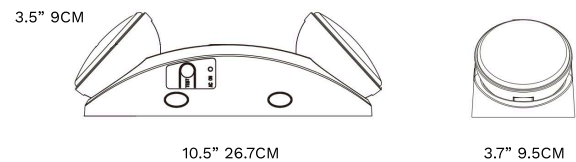
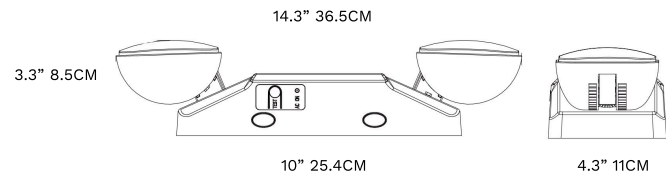

## Applications



Office Buildings



Commercial Lighting



Schools



Retail Stores

### Ordering Guide

SKU	Model	Voltage	Voltage	CCT	Battery/Lumens	Size
AA-BY-Z3125E	BY-Z3125E	AC120-347V	2 x 1.6W	6000K	Ni-Cd 3.6V/ 900mA battery, 1.5H	8.4 x 3.9 x 1.7"
AA-BY-Z3625U	BY-Z3625U	AC120-347V	2.5W	6000K - 7000K	Ni-Cd 3.6V 1200mAh battery, 2.0 H	10.5 x 3.7 x 3.5"
AA-BY-Z4430U	BY-Z4430U	AC120-347V	2.4W			14.3 x 4.2 x 3.3"

#### Warranty

10 Year Warranty. Extended Warranty Available.

#### Installation

Surface mount.



## LED Remote Heads

AA-BY-Z4430U

# LED Slim Panels

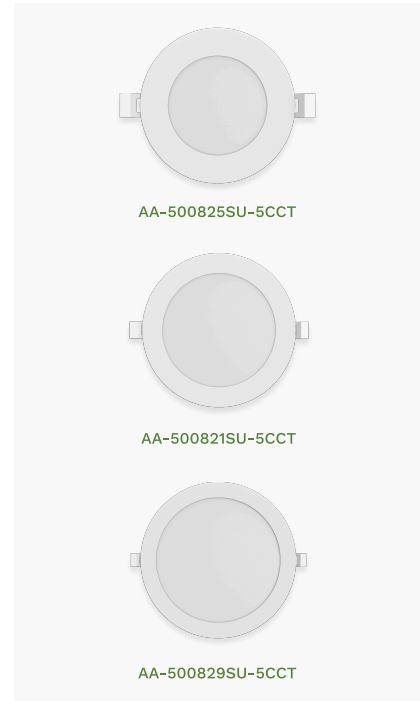

## Features

- Universal Input AC120-347V
- Multi CCT Selectable:  
27K/30K/35K/40K/50K
- Long rated lifetime of over 50,000 hours (L70)
- Flicker- free Triac dimming @ 120V, 0-10V dimming @ 120-347V
- FT4-Rated Cable Suitable for direct contact with insulation, IC-rated, and Air-Tight Certified for use in damp locations
- Energy Star Listed

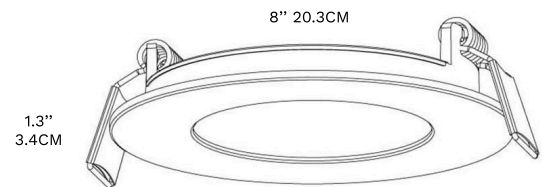
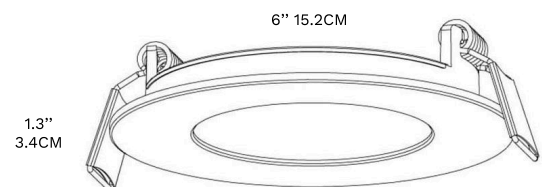
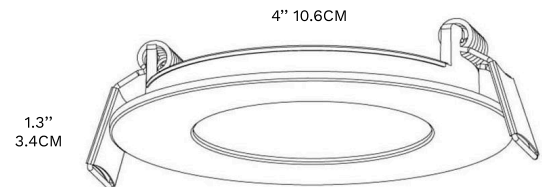

## Applications

- |  |   |
|--|---|
|  Office Buildings |  Commercial Lighting |
|  Schools          |  Retail Stores       |

## Ordering Guide

SKU	Model	Energy Star ID	Voltage	Wattage	Lumens	CCT	Size
AA-500825SU-5CCT	RP4IN8WUCCT	3439029	120	8	750	2700/3000/3500 /4000/5000K	4"
AA-500821SU-5CCT	RP6IN12WUCCT	3439039	-	12	1100		6"
AA-500829SU-5CCT	RP8IN16WUCCT	3439038	347	16			8"

### Warranty

10 Year Warranty. Extended Warranty Available.

### Installation

Recessed mounting. Goof rings available.

## Accessories (Sold Separately)

### Available Parts

SKU	Model	Description
AA-900019AA-4IN	900019AA-4IN	4 Inch Slim Downlight Goof Ring
AA-900019AA-6IN	900019AA-6IN	6 Inch Slim Downlight Goof Ring
AA-900019AA-8IN	900019AA-8IN	8 Inch Slim Downlight Goof Ring

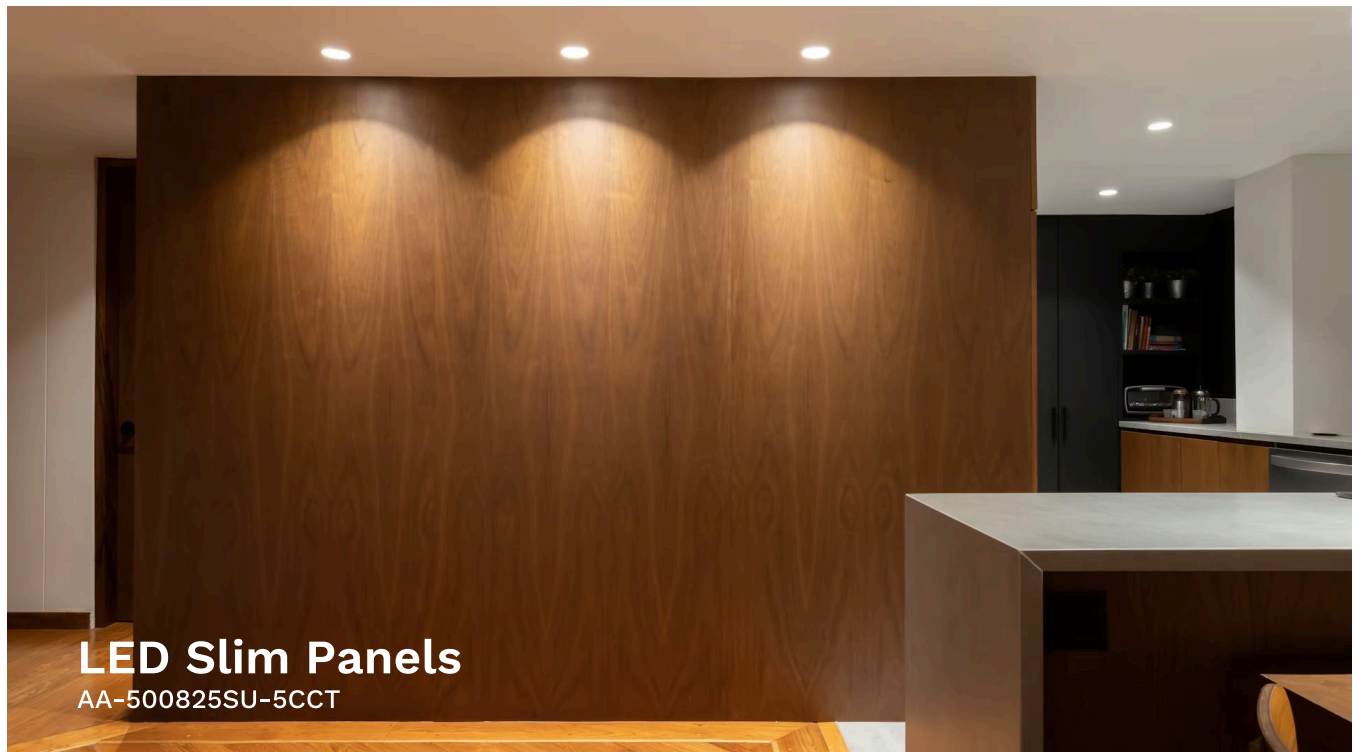

**LED Slim Panels**  
AA-500825SU-5CCT

# LED 4" & 6" Downlights



## Features

- Suitable for 4"/5"/6"/6" Can: Minimum Height 105mm, Diameter 130mm
- Eco-friendly, Mercury-free
- No UV, noise, or flickering
- Fully dimmable
- Replace 75W Incandescent/Halogens
- Shatterproof
- Approved for use in damp locations

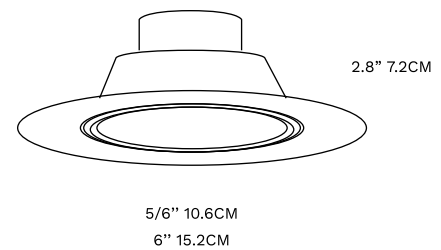

## Applications

- |  |   |
|--|---|
|  Office Buildings |  Commercial Lighting |
|  Schools          |  Retail Stores       |

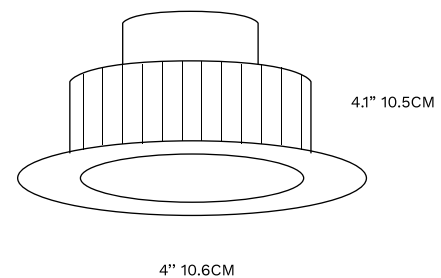

Ordering Guide

SKU	Model	Energy Star ID	Voltage	Wattage	Lumens	CCT	Size
AA-500820	D416-3000K	2261351	AC120	12	1100	3000K	6"
AA-500821	D416-4000K	2339632				4000K	5/6"
AA-500822	D416-5000K	2261353				5000K	
AA-500824	D404-3000K	2261367		9	650	3000K	4"
AA-500825	D404-4000K	2261368				4000K	
AA-500826	D404-5000K	2261369				5000K	

Warranty

10 Year Warranty. Extended Warranty Available.

Installation

Recessed mounting.



LED 4" & 6" Downlights  
AA-500820