

# Installation Instruction

## Additional Accessories

- Emergency Battery Back-up
  - YH34-08WL-50-X, YH34A-08WL-50-X

1. Take out and check the materials required for installation of emergency power supply.

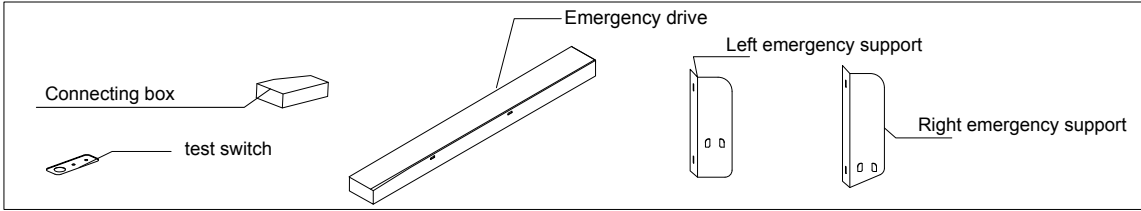

2. Remove the knockout on the side of the diver box.

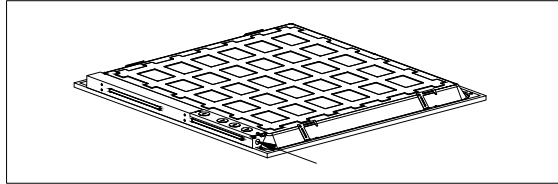
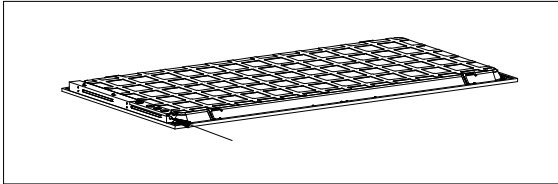

3. Move the grid clips to new location and install left and right emergency supports refer below figures.

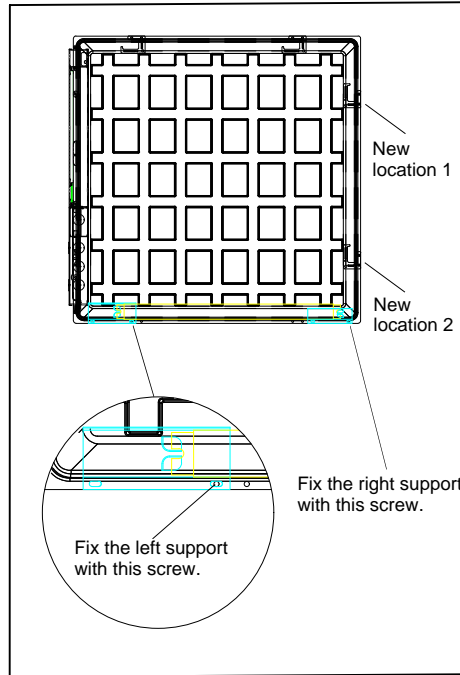
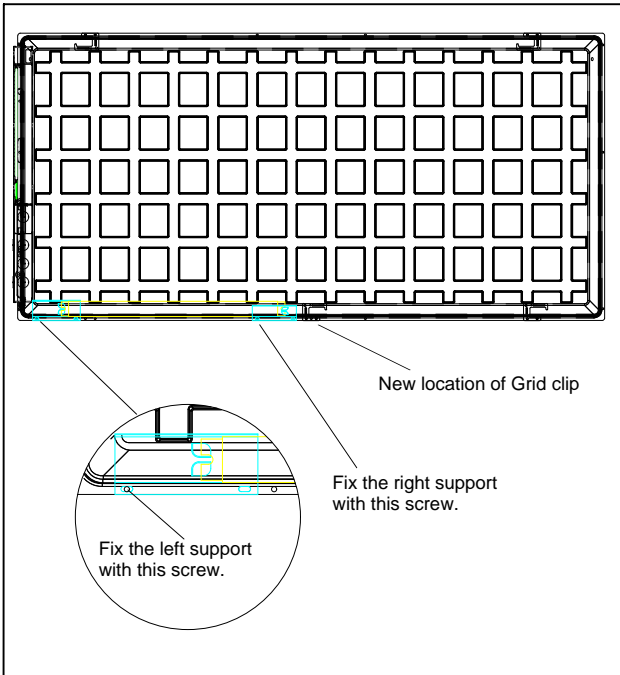

4. Install the emergency battery and do wiring connection refer to General Wiring Diagram.

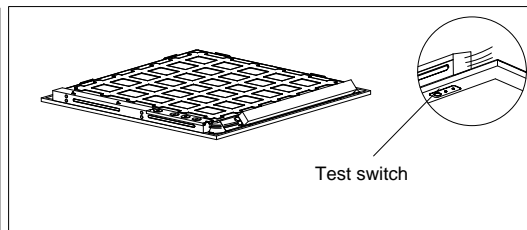
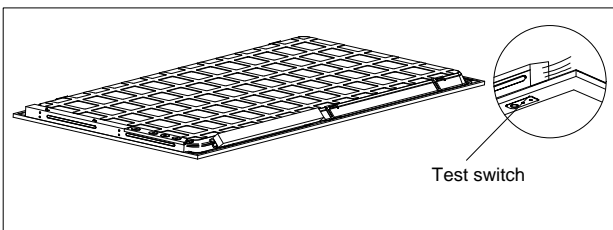

# Installation Instruction

5. Cover the connecting box.

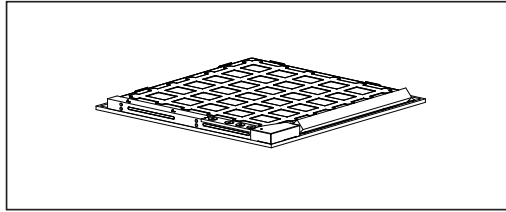
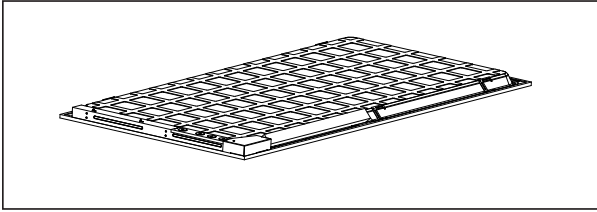

## General Wiring Diagram(Fixed CCT)

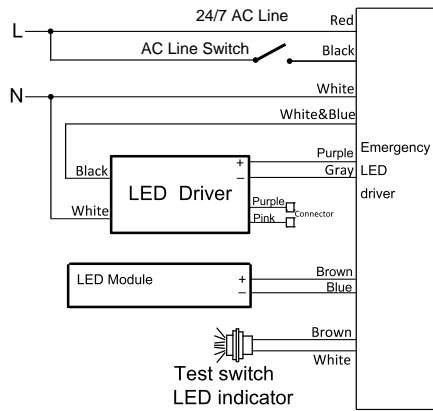

## General Wiring Diagram(CCT Adjustable)

