

LED LINEAR HIGHBAY



MODEL: LHBSL110W5KF120347V

SKU: 900073U

LED LINEAR HIGH BAY

ELAKEVIEW ENTERPRISE LTD.

PRODUCT DESCRIPTION

The Elakeview LED Linear Highbay provides high lumen efficacy and energy savings to projects in high ceiling applications. This highbay is an excellent energy efficient replacement for HID or fluorescent fixture.



HIGHLIGHTS

- DLC Premium Listed
- Efficacy-140LM/W
- Mounting V-Hooks/Chain provided.
- Receptacle for Microwave Dimming Sensor (Sensor Sold Separately)
- Optional pendant mount
- Wire guard available
- Damp location rated
- Optional clear or frosted lens
- CRI > 80
- AC120-347V Dimming Driver with 4KV surge protection
- 5 Year warranty. Extended Warranty Available
- L70 - 50,000 hours



lighting facts™
A Program of the ILLDIF



APPLICATIONS

Designed for manufacturing, industrial, shops, corridor, garage, gymnasium, office, retail and warehouse applications.

ORDERING INFORMATION

ORDER SKU	DLC MODEL #	DLC PRODUCT ID	INPUT VOLTAGE	POWER (W)	EFFICACY (LMW)	DELIVERED LUMENS	CCT(K)	FINISH	SIZE
900071U	AALHBP85W5KF120347V	PL3T6SMUKUTR	AC120-347V	85W	136LMW	11560LM	5000K	White	2FT
900073U	LHBSL110W5KF120347V	S-9I583W	AC120-347V	110W	140LMW	15659LM	5000K	White	2FT
900074U	LHBSL110W4KF120347V	S-04U8VX	AC120-347V	110W	135LMW	15209LM	4000K	White	2FT
900075U	LHBSL160W5KF120347V	S-EU96P0	AC120-347V	160W	141LMW	22474LM	5000K	White	2FT
900076U	LHBSL160W4KF120347V	S-C9Z7E2	AC120-347V	160W	137LMW	21999LM	4000K	White	2FT
900077U	LHBSL220W5KF120347V	S-IP8FQB	AC120-347V	215W	140LMW	30172LM	5000K	White	4FT
900079U	LHBSL320W5KF120347V	S-OPXNMR	AC120-347V	316W	141LMW	44645LM	5000K	White	4FT

REV 1



LED LINEAR HIGH BAY

ELAKEVIEW ENTERPRISE LTD.

PRODUCT FEATURE

- LED Saves 70-80% of energy over HID and 50-60% over T8/T5HO.
- Die formed of 24 gauge cold-rolled steel body.
- All steel surface are painted after fabrication with high gloss baked white matte powder painted.
- 2x Mounting hooks & 2x 40' Chains included
- Damp location rated.
- CRI > 80
- Tool-Less Hinged bottom LED Driver access doors.
- High transmission opaque acrylic lens.
- High LMW (Lumen per watt) LM80 Approved Seoul LED's
- Receptacle for Microwave Dimming Sensor (Sensor Sold Separately)
- cETLus, RoHS Compliant, Design Lights Consortium (DLC) Qualified Products List

• 5 years warranty, 100,000hrs Lifespan, Extended warranty terms available

PRODUCT SPECIFICATIONS

LED TYPE	WATTS	SYSTEM EFFICACY	LUMENS	COLOR TEMP	BEAM ANGLE	CRI	VOLTAGE	POWER FREQ	POWER EFFICIENCY	POWER FACTOR	THD
SEOUL	110W	140LMW	15659LM	5000K	120°	>80	120-347V	50/60HZ	86%-87%	> .90	< 10%

DIMENSIONS

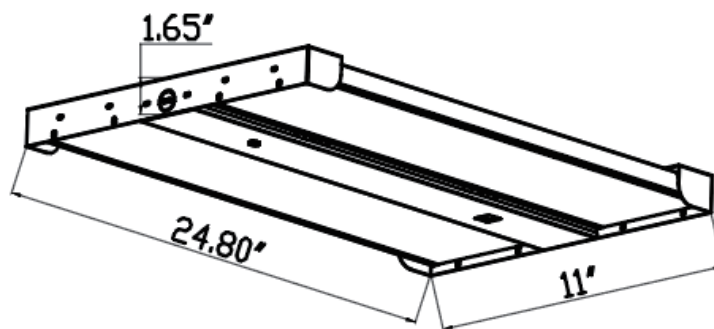

MOUNTING OPTIONS

V-Hooks/Chain provided

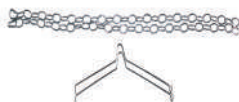

Optional Pendant Mount



OPTIONAL ACCESSORIES

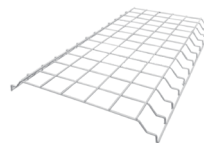

WIREGUARD

SKU | LHWG110W



Microwave Dimming Sensor

SKU | HD06VCHR3

REV 1



PHOTOMETRIC INFORMATION

Lamp Output: Total luminaire Lumens: 13951.1
 Max Candela: 5,535.5 at Horizontal: 112.5°, Vertical: 3°
 Input Wattage: 103.7
 Luminous Opening: Rectangle (L: 23.35", W: 12.32")
 Photometry : Type C

ISOFOOTCANDLE PLOT

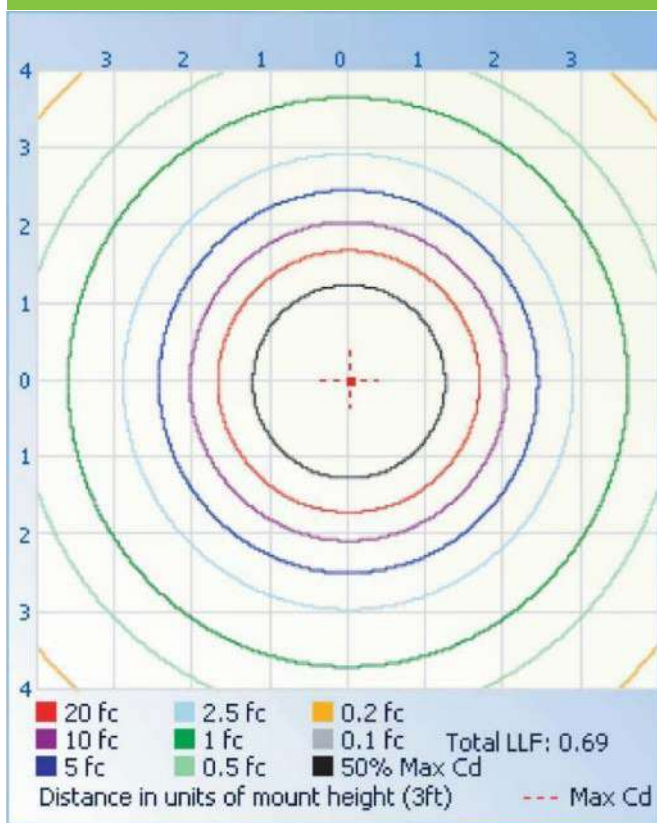

POLAR CANDELA DISTRIBUTION

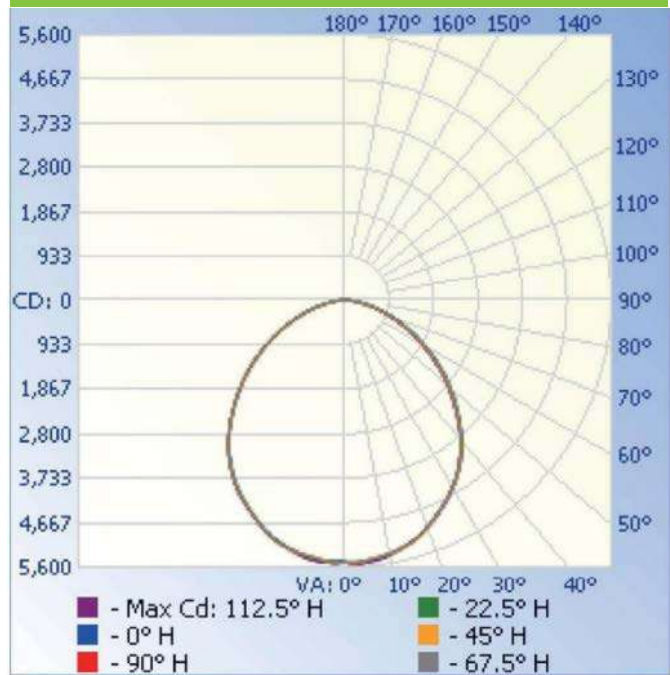

ILLUMINANCE AT A DISTANCE

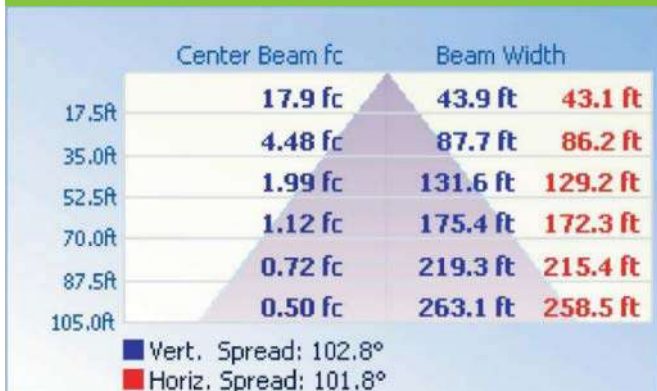

ROADWAY UTILIZATION CURVE

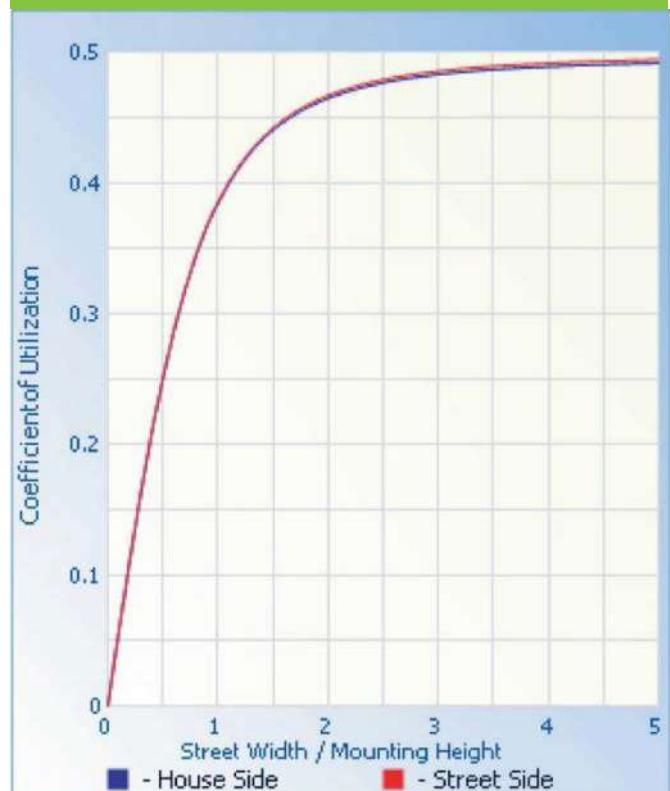

REV 1