

LED LINEAR HIGHBAY



MODEL: LHBSL92WUCCTW

SKU: 900073UCCTW

LED LINEAR HIGH BAY

ELAKEVIEW ENTERPRISE LTD.

PRODUCT DESCRIPTION

The Elakeview LED Linear Highbay provides high lumen efficacy and energy savings to projects in high ceiling applications. This highbay is an excellent energy efficient replacement for HID or fluorescent fixture.



HIGHLIGHTS

- DLC Premium Listed
- Wire guard available
- AC120-347V Class2 0-10V Dimming Driver, 4/6KV surge protector, w/overtemperature protection
- Mounting V-Hooks provided
- 4000K/5000K Selectable
- Optional pendant mount
- 78/92/155W Selectable
- Damp location rated
- Efficacy-155LM/W
- CRI > 80
- L70 - 100,000 hours
- 5 Year warranty. Extended Warranty Available
- Receptacle for Microwave Dimming Sensor (Sensor Sold Separately)



lighting facts™



APPLICATIONS

Designed for manufacturing, industrial, shops, corridor, garage, gymnasium, office, retail and warehouse applications.

ORDERING INFORMATION

ORDER SKU	DLC MODEL #	COLOR RENDERING INDEX (CRI)	INPUT VOLTAGE	POWER (W)	EFFICACY (LMW)	DELIVERED LUMENS	CCT(K)	FINISH	SIZE
900073UCCTW	LHBSL92WUCCTW	81	AC120-347V	78/92/115	155	12090-17365	4000/5000	White	1.4FT
900075UCCTW	LHBSL155WUCCTW	81	AC120-347V	135/155/185	155	20925-29735	4000/5000	White	1.9FT
900077UCCTW	LHBSL230WUCCTW	81	AC120-347V	200/230/270	155	30800-40770	4000/5000	White	2.6FT

REV 1

PRODUCT FEATURE

- AC120-347V Class2 0-10V Dimming Driver, 4/6KV surge protector, w/overtemperature protection
 - Tool-Less Hinged bottom LED Driver
 - High LMW (Lumen per watt) LM80 Approved Seoul LED's
 - Receptacle for Microwave Dimming Sensor (Sensor Sold Separately)
 - High transmission opaque acrylic lens.
 - Damp Location rated.
 - CRI>80
 - Die formed of 24 gauge cold-rolled steel body.
 - All steel surface are painted after fabrication with high gloss baked white matte power painted.
 - 2 x Mounting hooks included.
 - UL/cUL Listed, RoHS Compliant, Design Lights Consortium (DLC) Qualified Products List
- 5 years warranty, 100,000hrs Lifespan, Extended warranty terms available

PRODUCT SPECIFICATIONS

LED TYPE	WATTS	SYSTEM EFFICACY	LUMENS	COLOR TEMP	BEAM ANGLE	CRI	VOLTAGE	POWER FREQ	POWER EFFICIENCY	POWER FACTOR	THD
SEOUL	78/92/115W	155LMW	12090-17365	4000/5000K	120°	>80	120-347V	60HZ	99%	>.90	< 10%

DIMENSIONS

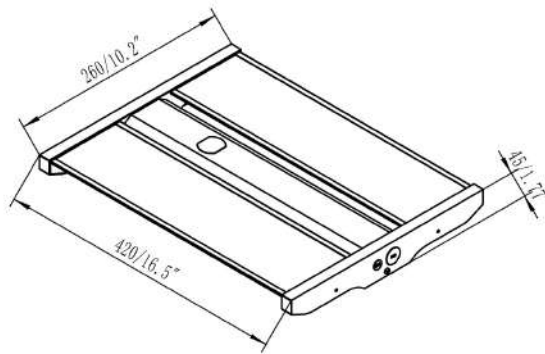

MOUNTING OPTIONS

V-Hooks provided



Optional Pendant Mount



OPTIONAL ACCESSORIES

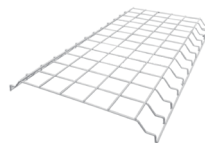

WIREGUARD

SKU LHWG160W



Microwave Dimming Sensor

SKU HD06VCHR3

LED LINEAR HIGH BAY

ELAKEVIEW ENTERPRISE LTD.

POLAR CANDELA DISTRIBUTION

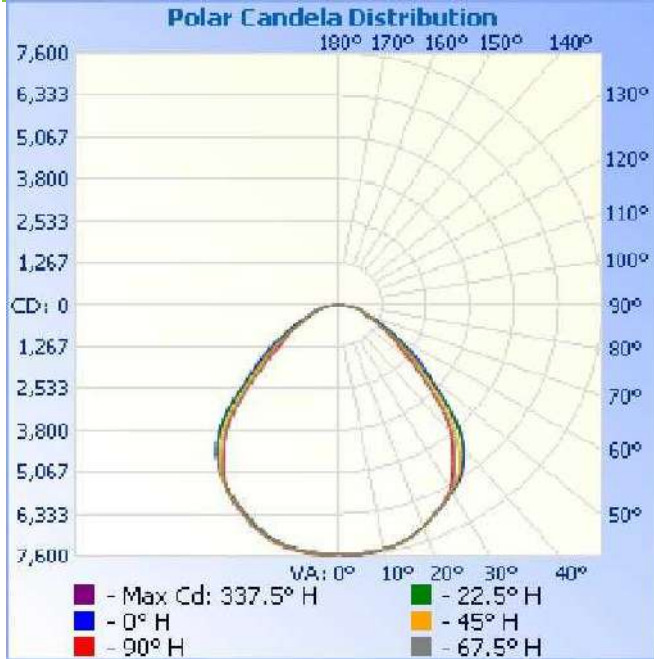

ISOCANDELA PLOT

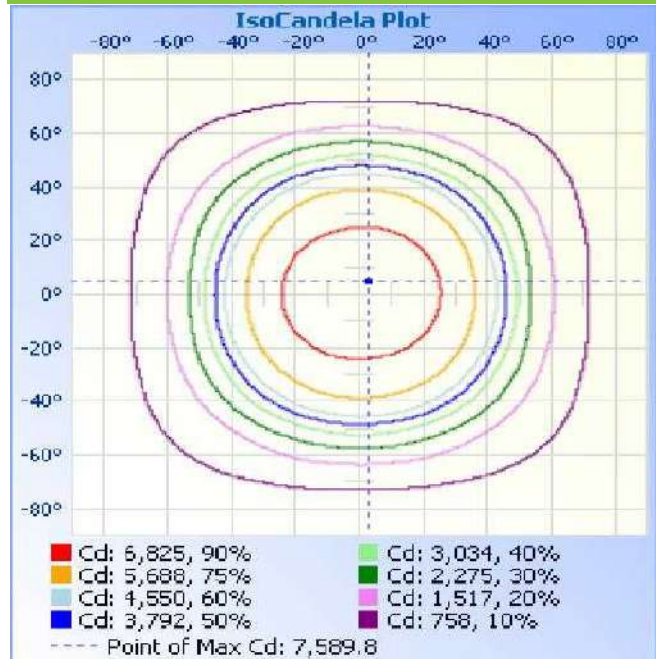

INTERGRATING SPHERE TEST

ANSI/IES TM-30-18 Color Rendition Report

Source: BXEN-(A)E-21L-3C
Date: 1/7/2023

Manufacturer: Jiangsu Ever-tie Lighting Inc
Model: ETLB5A2-1.4/2/PJ/115/92/78/RD1/CCT /3/AU1/F1/A3/B7/SN/EMN

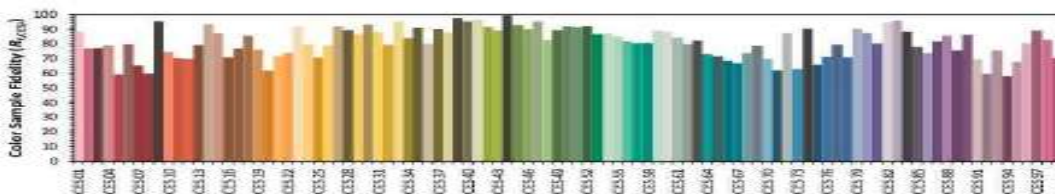
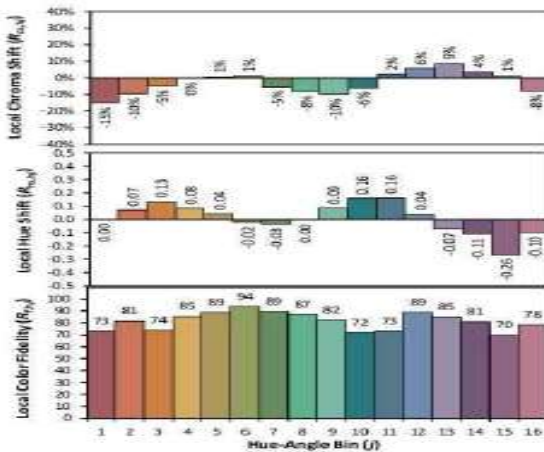
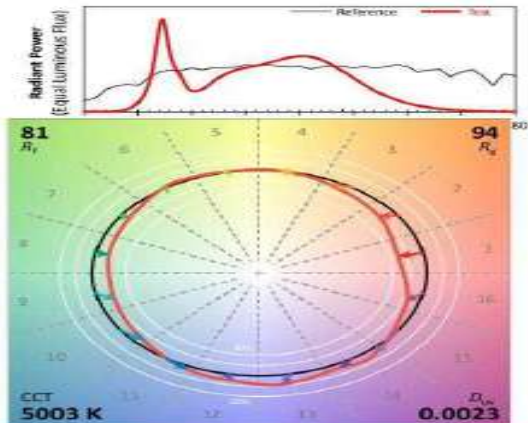

Notes: This is a recommended method for displaying ANSI/IES TM-30-18 information.

x: 0.3455
y: 0.3565
u': 0.2098
v': 0.4871

CIE 13.3-1995 (CRI)
 R_a : 80
 R_g : -12

Colors are for visual orientation purposes only. Created with the ANSI/IES TM-30-18 Calculator Version 2.00.

REV 1